

CATTLE GRID

40 Tonne

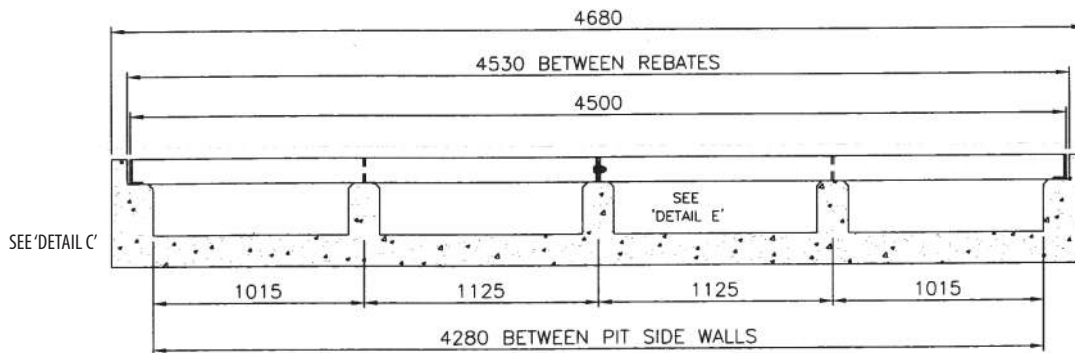

DRAWING NO: CG-40

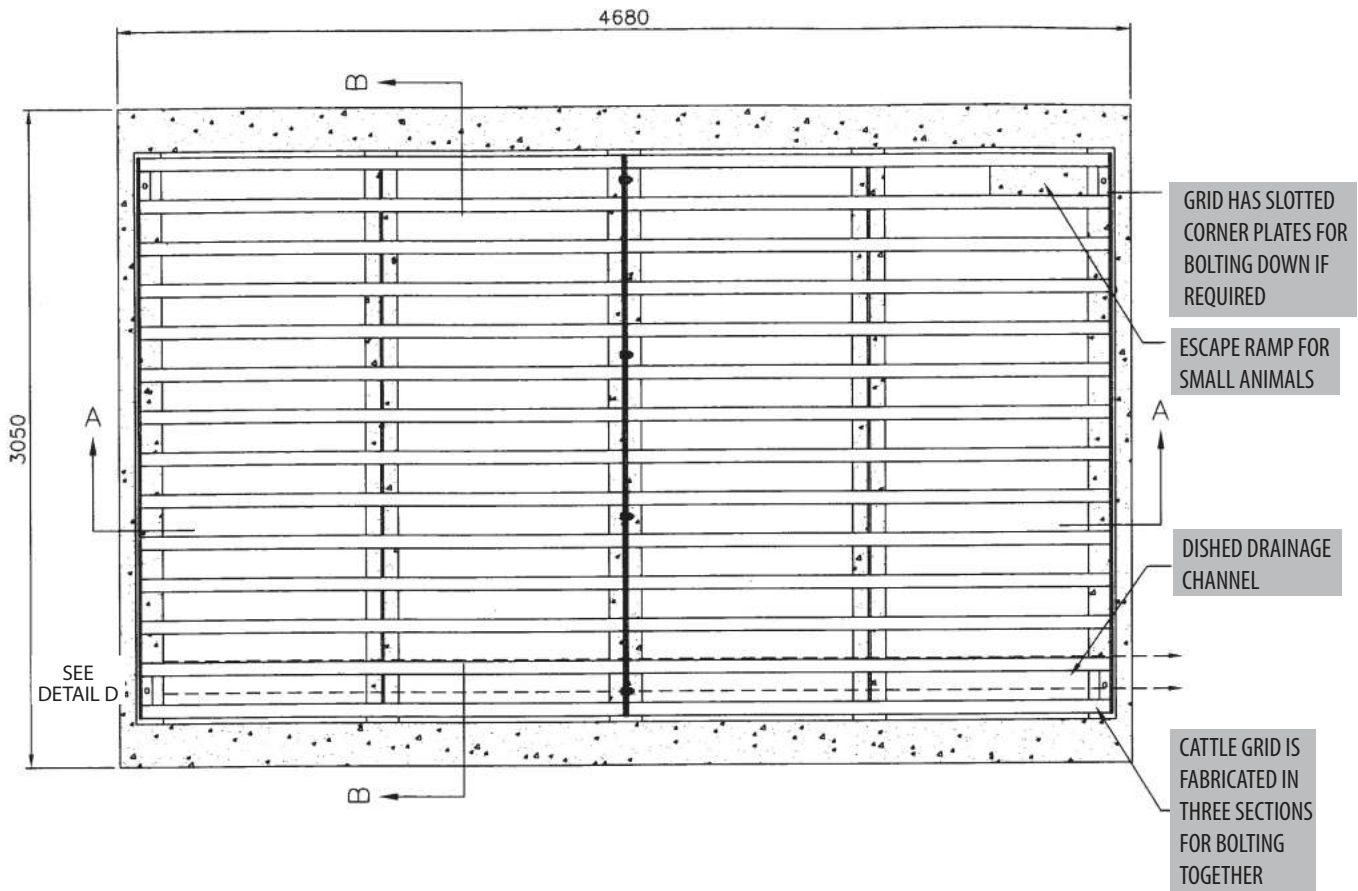

SECTION A- A

PLEASE NOTE

Guard Fencing needs to be erected on both sides of the cattle grid to prevent encroachment by animals and also to position vehicles correctly on the approach to the grid.

TEL: +44(0)1782 339320
FAX: +44(0)1782 339322
sales@iae.co.uk
www.iae.co.uk

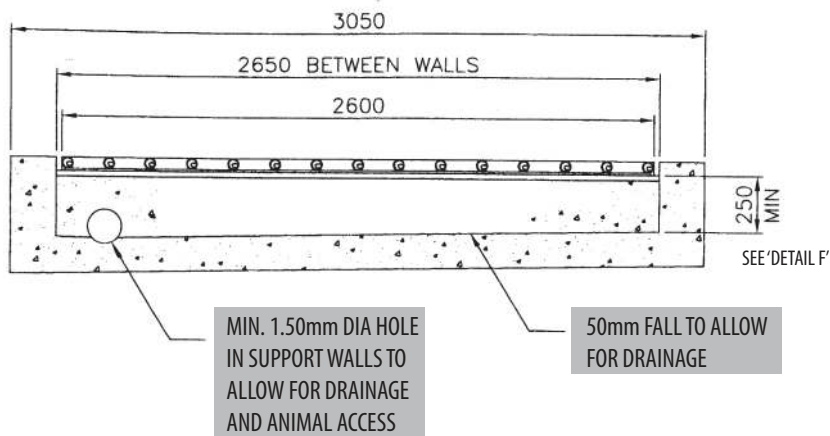

SECTION B - B

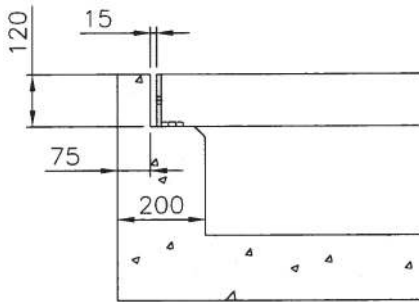

DETAIL - C

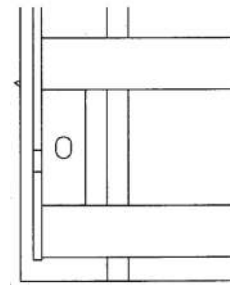

DETAIL - D

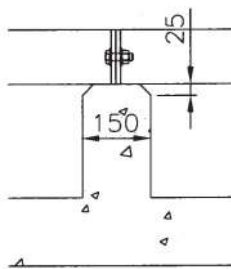

DETAIL - E

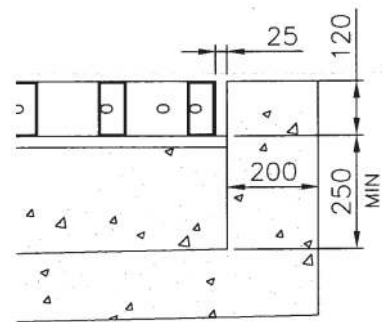

DETAIL - F

PLEASE NOTE

Guard Fencing needs to be erected on both sides of the cattle grid to prevent encroachment by animals and also to position vehicles correctly on the approach to the grid.

TEL: +44(0)1782 339320
FAX: +44(0)1782 339322
sales@iae.co.uk
www.iae.co.uk