

## FELCO 51 - Grøn

- Klovsaks

Made in Switzerland by FELCO



220mm/8.7in. 260g/9.2oz.



- > **Pålidelighed:** behagelige håndtag, lette og solide udført i smedet alu med livsgaranti\* / skruemonteret klinge og underklinge i hærdet stål af høj kvalitet / rent og præcist snit / alle dele kan udskiftes
- > **Effektivitet:** justering af snittet er let og holdbar / Beskyttelse mod risikoen for klovinfektion, da klingerne er coated med XYLAN<sup>®</sup>-
- > **Ergonomi:** beskytter hånden og håndleddet og forøger ydeevnen takket være håndtagets perfekte udformning, det nedadvendte klinge hoved og støddæmper / sikret greb, non-slip

## ANBEFALET TIL

Vor anbefaling ( ★ = Anbefalet, ★ ★ = Kraftig anbefaling, ★ ★ ★ = Passer bedst )

Slibning/rømning	★ ★ ★
Lille hånd	★ ★ ★
Hånd af gennemsnitsstørrelse	★ ★ ★
Stor hånd	★ ★ ★
Højrehåndet	★ ★ ★
Venstre-hånd	★ ★ ★

## KLIPPEEGENSKABER

### Materiale

### Maksimum skære diameter

Får/ged hove



## TILBEHØR



FELCO 902  
Slibe værktøjer  
Slibesten



FELCO 903  
Slibe værktøjer  
Slibesten



FELCO 910  
Hylstre  
Læder - Med bælttestrop og -clips



FELCO 912  
Hylstre  
Læder - Med bælteclips



FELCO 980

Vedligeholdelse produkter  
Spray



FELCO 990







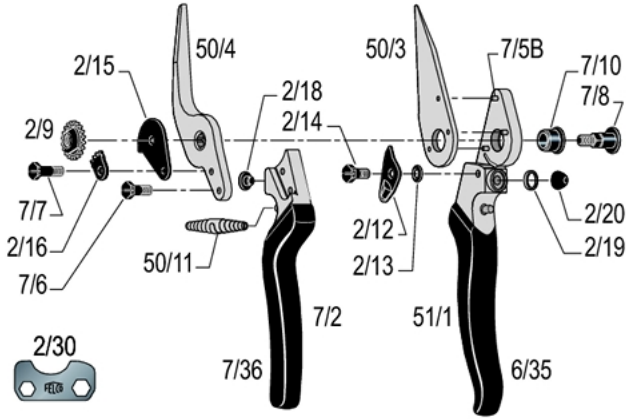























Vedligeholdelse produkter  
Fedt





---

## RESERVEDELE



FELCO	Ref.:	Beskrivelse	Udarbejdelse	UCC vare kode
	2/30	Justerings nøgle	1x 2/30	7 83929 40163 8
	50/3	Kniv	1x 50/3	7 83929 40098 3
	50/4	Ambolt-kniv	1x 50/4	7 83929 40099 0
	7/90	Sæt	1x 7/7 + 1x 2/16 + 1x 2/9 + 1x 7/8	7 83929 40017 4
	2/92	Sæt	1x 2/15 + 1x 2/18 + 1x 2/14 + 1x 2/12 + 1x 2/13 + 1x 2/20	7 83929 40020 4
	2/93	Sæt	4x 2/18 + 6x 2/20	7 83929 40021 1
	7/94	Sæt	1x 2/9 + 1x 7/8	7 83929 40028 0
	51/1	Håndtag uden kniv	1x 51/1 + 3x 7/5B + 1x 2/19 + 1x 2/20 + 1x 7/10 + 1x 2/13 + 1x 2/12 + 1x 2/14 + 1x 6/35	7 83929 40215 4
	7/2	Håndtag uden ambolt-kniv	1x 7/2 + 1x 2/18 + 1x 7/36	7 83929 40236 9

	6/35	Overtræk for kniv håndtag	1x 6/35	 7 83929 40219 2
	7/36	Plastik overtræk for ambolt-kniv/ambolt håndtag	1x 7/36	 7 83929 40239 0
	7/5B	Nitte for kniv	1x 7/5B	 7 83929 40240 6
	7/6	Skrue for ambolt-kniv	1x 7/6	 7 83929 40241 3
	7/8	Bolt	1x 7/8	 7 83929 40243 7
	2/9	Møtrik	1x 2/9	 7 83929 40169 0
	7/10	Bøsning	1x 7/10	 7 83929 40235 2
	50/11	Hvid fjeder	1x 50/11	 7 83929 40214 7
	2/12	Tommelfinger greb	1x 2/12	 7 83929 40153 9
	2/13	Fjeder for tommelfinger greb	1x 2/13	 7 83929 40154 6
	2/14	Skrue for tommelfinger greb	1x 2/14	 7 83929 40155 3
	2/15	Låseplade	1x 2/15	 7 83929 40156 0
	2/16	Låse stykke	1x 2/16	 7 83929 40157 7
	7/7	Skrue for låse stykke	1x 7/7	 7 83929 40242 0
	2/18	Hynde	1x 2/18	 7 83929 40159 1

	2/19	Skær	1x 2/19	 7 83929 40160 7
	2/20	Stød absorber	1x 2/20	 7 83929 40162 1

## SERVICE

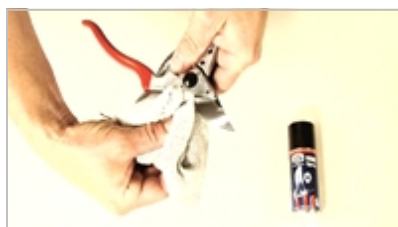

### Rengøring

Vi anbefaler at du rengør dit værktøj efter hver brug. Hvis dit værktøj er meget snavset eller der er optræk til rust efter værktøjet har været udsat for fugt, rengør omgående.



### Smøring

Når du har rengjort, anbefaler vi at du smører værktøjet for at beskytte det mod tæring. Olien vil også sørge for at værktøjet ikke blokerer.

## UDSKIFTNING AF RESERVEDELE



### Udskiftning af støddæmper

Når værktøjet lukker for hurtigt/hårdt når der beskæres, og gummi puderne er i god stand, er det på tide at skifte støddæmperen.



### Udskiftning af gummi puder

Når værktøjet lukker for hurtigt/hårdt når der beskæres og støddæmperen er i god stand, skal gummipuderne skiftes.



### Udskiftning af tommelfinger greb

Når tommefingergrebet er ødelagt og løs ved brug, selvom skruen er justeret, skift.



### Udskiftning af plastik overtræk til håndtag

Hvis overtrækket er alvorligt ødelagt, kan det skiftes.

Blødgør overtrækket i 2 minutter ti kogende vand - anbefalet lim: Loctite 415.